



**maxspect**  
Envision life vividly



## INTRODUCING WORLD'S FIRST "GYRE-GENERATOR"



Owner's Manual



***Dear Customer,***

Thank you for purchasing this product.

For optimum performance and safety, please read these instructions carefully.

English

**User Memo:**

Date of purchase: \_\_\_\_\_

Dealer name: \_\_\_\_\_

Dealer address: \_\_\_\_\_

Dealer website: \_\_\_\_\_

Dealer email: \_\_\_\_\_

Dealer phone no.: \_\_\_\_\_

**Please visit us on facebook or twitter!**



<https://www.facebook.com/Maxspect>



<http://twitter.com/maxspectled>

# Package Content

Please check the content in the package.

English

**Gyre Pump Module**



**Basic Controller**



**Power Supply Unit**



**Spare Rotors and Flow Cages**



Before using this Maxspect™ Gyre System please read these operating instructions carefully. Take special care to follow the safety suggestions listed below.

Afterwards keep this manual handy for future reference.

## Before using the Maxspect™ Gyre System

1. Remove any plastic bags and packaging material protecting the pump and controller unit.

## Safety on Power Supply

1. **Power Source** – Do not defeat the safety purpose of the polarized or grounding-type plug. A polarized plug has two blades with one wider than the other. A grounding-type plug has two blades and a third grounding prong. The wide blade or the third prong is provided for your safety. If the plug does not fit into your outlet, consult an electrician for replacement of the obsolete outlet.
2. **Power Cord Protection** – The power supply cords should be routed so that they are not likely to be walked on or pinched by items placed upon or against them. Never take hold of the plug or cord if your hand is wet, and always grasp the plug body when connecting or disconnecting it.
3. **Installation** – Install indoor only, and use the attachments and accessories provided and specified by the manufacturer.

## Safety on Magnet Mount

1. **CAUTION - Very strong magnetic mount** included in the package.
2. **CAUTION** - keep the magnet mount out of reach of children, as there is risk of severe personal injury otherwise!
3. Handle the magnet mount with their proper handle, and do not bring the both side together directly. Do not put your fingers between the magnet mounts.
4. Magnet mount can attract metal objects, keep clear of metal objects when handling the magnetic mount to avoid injuries.
5. Magnet mount can also damage electronic and magnetic storage devices such as USB storage devices, pacemakers, credit cards, etc. Keep clear of these devices when handling the magnetic mount to avoid damaging them.

## Safety on Pulsing Motion generated by the Gyre System

1. Making pulses and waves with the Gyre System can place additional stress on the aquarium glass/acrylic and its joints. Not all aquariums are able or designed to withstand this stress and failure of the glass/acrylic and/or joints could result. Please consult with your aquarium manufacturer to determine if the aquarium construction is adequate to withstand the additional stress generated by the pulses and waves motion. Please also check to assure that your aquarium stand or furniture is properly leveled, which will help reduce the additional stress resulting from wave generation.
2. Maxspect DISCLAIMS AND WILL NOT BE LIABLE FOR, damage to any aquarium or their surroundings, water damage, or any other consequential damages resulting from wave generation. MAKE PULSES AND WAVES AT YOUR OWN RISK.

## Operation – Controller Unit

1. **Operation** – Always follow the operation instructions set forth in this manual when using this controller unit.
2. **Heat** – The controller unit should be situated away from heat sources such as radiators, and do not expose to excessive heat such as sunshine, fire or the like.
3. **Moisture** – To reduce the risk of fire or electric shock, do not expose the controller unit to rain, moisture, dripping or splashing.
4. **Water Damage** – DO NOT immerse in water. If the controller unit falls into the water, DO NOT reaches for it! First unplug it and then retrieve it. If electrical components of the appliance get wet, unplug the appliance immediately.

## Operation – Gyre Pump

1. **Placement** – The Gyre pump creates high levels of flow within your aquarium. Please place the Gyre in an area where corals are not too close to the output flow of the pump.
2. **Stall** – In the event of a motor stall, the Gyre pump may have stopped for a few possible reasons. You should first check that there is not something blocking the rotors from spinning.
3. **Overheating** – The Gyre pump is designed to run underwater. Do not run the Gyre pump when it is not submerged in water. Doing so will cause the Gyre pump module to overheat and could damage the pump component.
4. **Cleaning** – Please follow the instruction in this manual to clean the Gyre regularly.
5. **Power Outage** – During power outage, if a battery backup accessory is added to the Gyre pump, the pump will automatically switch to Battery Backup mode during a power outage. The pumps will run at the minimum speed to maximize their run time during this critical period.

## Mounting the Gyre System

1. The Gyre System has a built-in safety mechanism. You must first connect the cable from the Controller to the Gyre Pump then connect the cable from the Power Supply to the Controller.

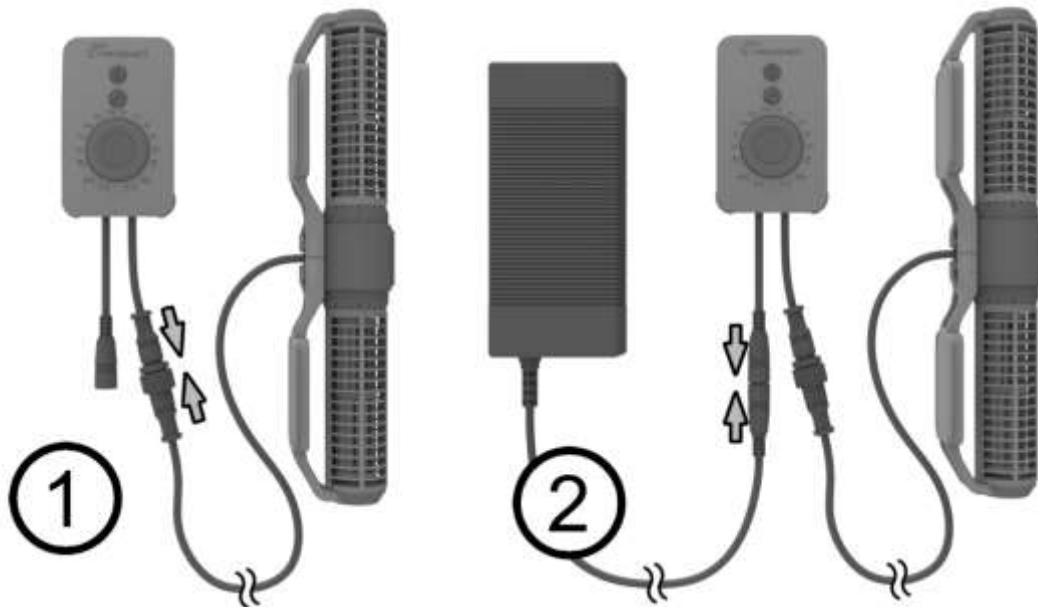

2. Mount the Controller Cradle to a flat surface, such as the glass or acrylic panel of your aquarium, or the aquarium stand.



## Installation

3. Please choose a location where you intend on installing your Gyre pump, and clean the area using a razor blade to remove all algae.
4. Make sure the glass or acrylic panel of your aquarium is within the recommended thickness of 15mm (1/2"). For aquariums with glass or acrylic panel between 15-20mm (1/2" to 3/4"), you may need to use the optional reinforcement magnet kit (sold separately).
5. Secure the Gyre Pump as illustrated below.

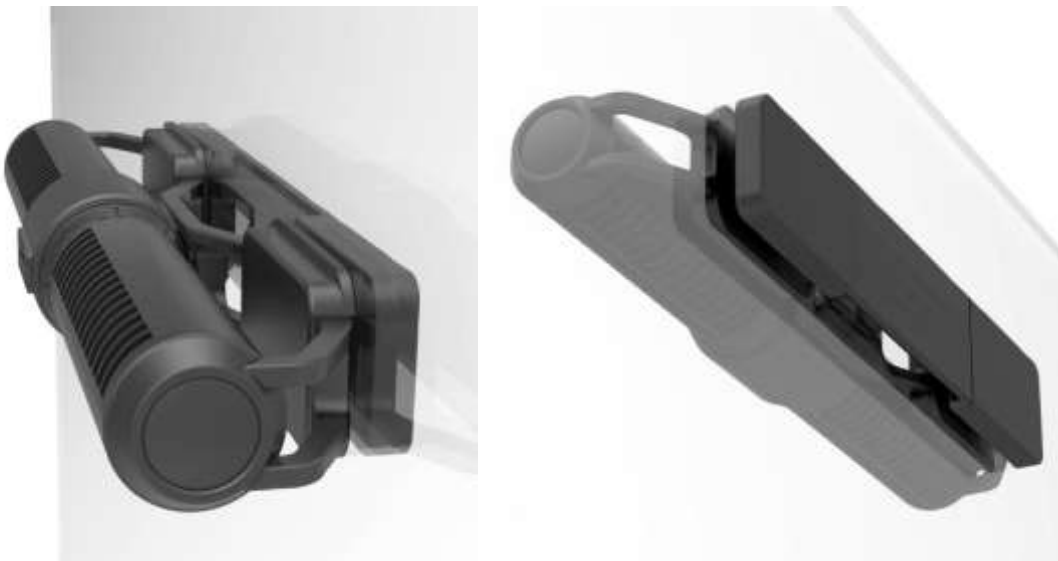

### Adjusting the angle of the Flow Cages

1. Rotate the Flow Cages clockwise or counter-clockwise to adjust the angle of the water flow.





# Operating Instructions

English

## The Gyre Controller Unit

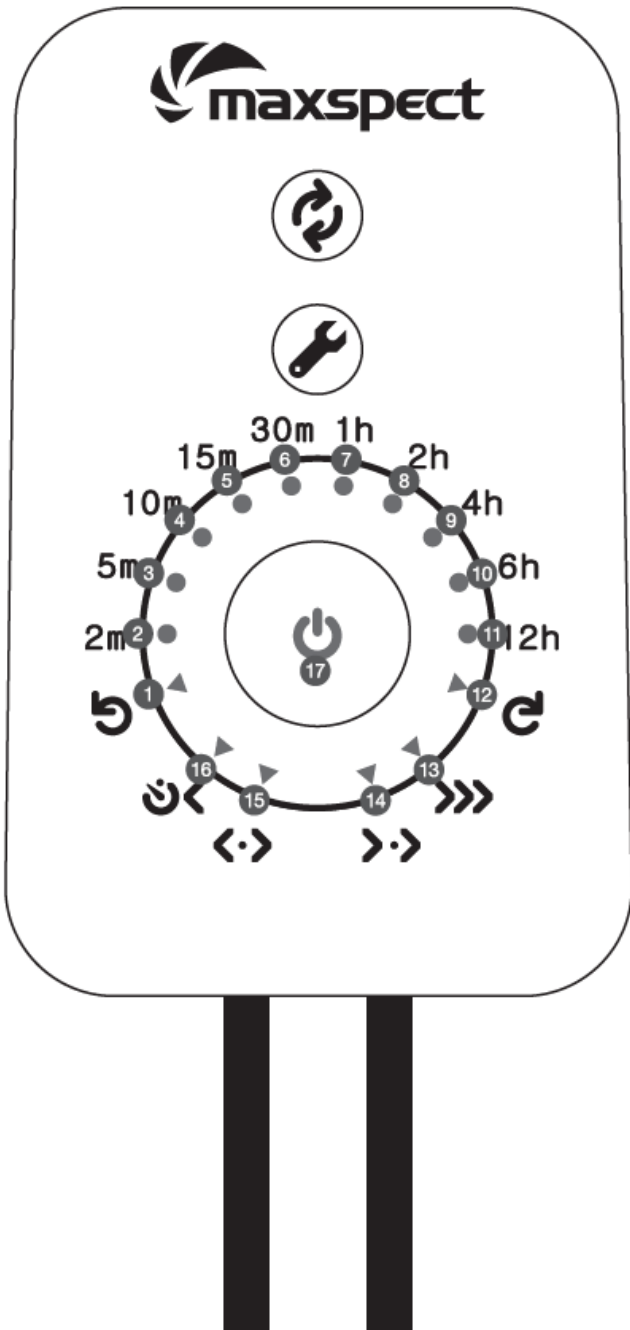

Switch Mode Button



Setup Mode Button



2-11

Control Dial with Indicator Lights



1

Normal Flow Indicator



12

Reverse Flow Indicator



13

Constant Speed Mode



14

Pulsing Mode



15

Alternating Gyre Mode



16

Feeding Mode



17

Status Indicator Light

## Status Light Indicator

English



Blue Light

Gyre System is working normally.



Blue Light Flashing

Gyre System is in Feeding Mode.



Red Light

Emergency - Gyre System is stopped.  
(Please refer to troubleshooting guide.)



Red Light Flashing

Warning - Gyre System raised an alert.  
(Please refer to troubleshooting guide.)



Green Light

Gyre System is in Setup Mode.

## Turn on/off the Controller Unit

### 1. Make sure the Controller Unit is not in Setup Mode.

 Status Indicator Light is not in green color.

### 2. Press and hold the Switch Mode button for 4 seconds to turn on/off the Controller Unit.



#### Note

The Controller Unit turns on automatically when power is connected, and turns off when power is cut.

When power is turned on or resumed, the Controller Unit will restore to the previous saved setting automatically.

## Switching between Modes

1. Press the Switch Mode button to cycle between the 4 Modes.

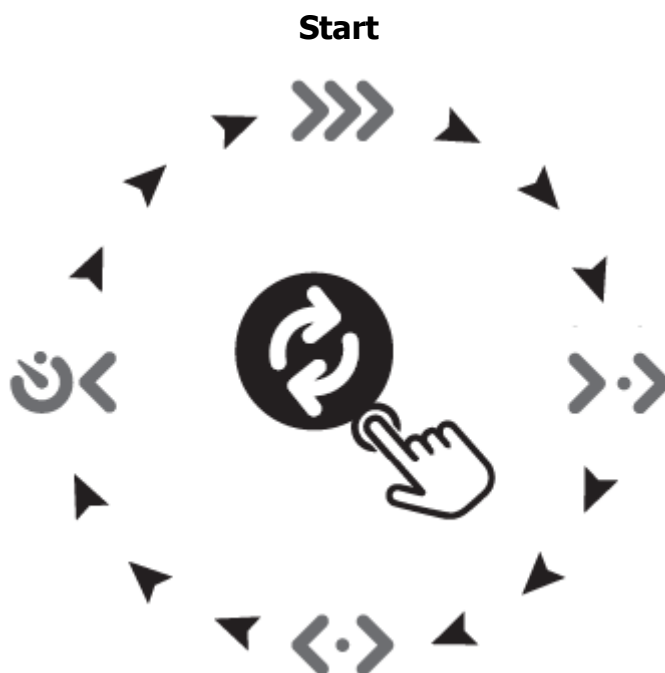

## Entering Setup Mode

1. Press the Setup Mode button once. The Status Indicator Light will turn green.



2. Press the Setup Mode button again to confirm the switch and leave Setup Mode. The controller will also exit Setup Mode if the Controller Unit has been idling for 60 seconds. The Status Indicator Light will return to blue.



## »»» Constant Speed Mode

English

1. Switch to Constant Speed Mode, then enter Setup Mode.

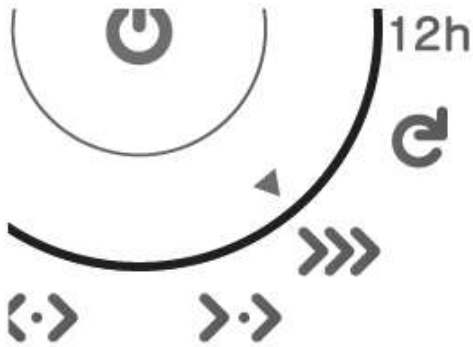

2. Adjust the water flow speed by rotating the Control Dial clockwise or counter clockwise.

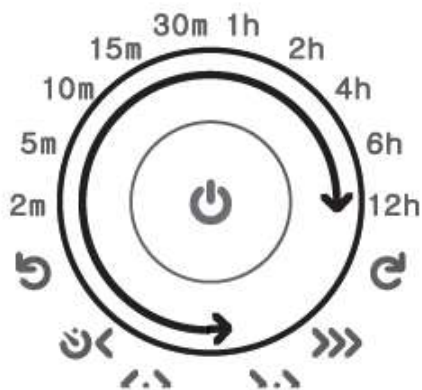

3. The Indicator Lights (2-11) on the Control Dial indicates the current water flow speed.

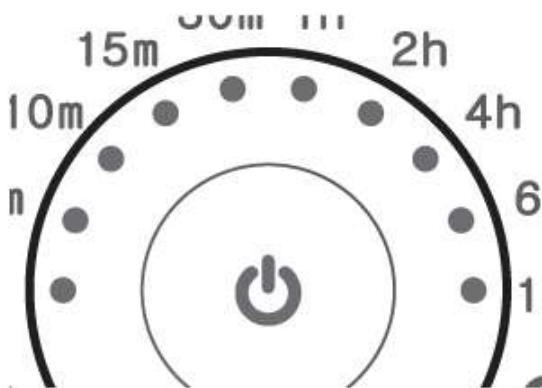

## »»» Constant Speed Mode

4. The following diagrams illustrate what the Control Dial looks like at different water flow speed, normal and reverse flow.

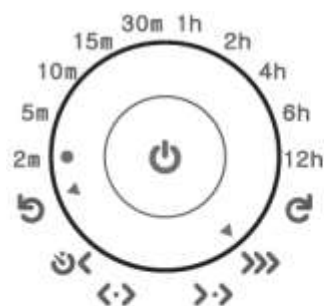

**Normal Flow 10%**

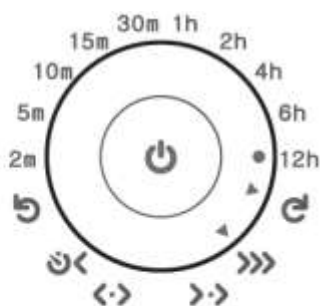

**Reverse Flow 10%**

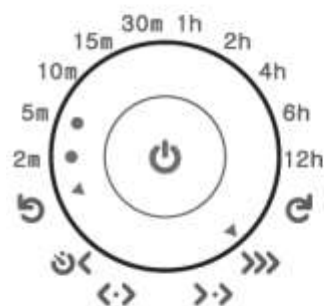

**Normal Flow 20%**

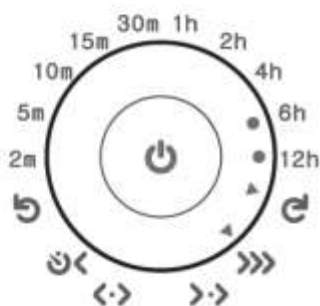

**Reverse Flow 20%**

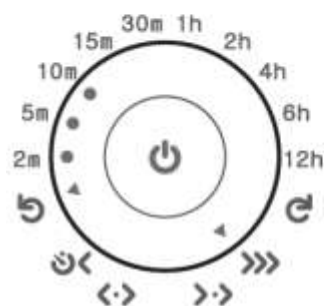

**Normal Flow 30%**

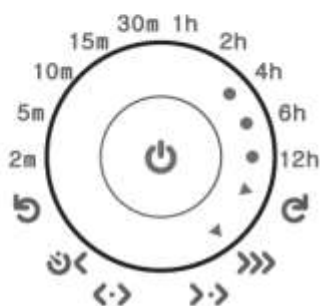

**Reverse Flow 30%**

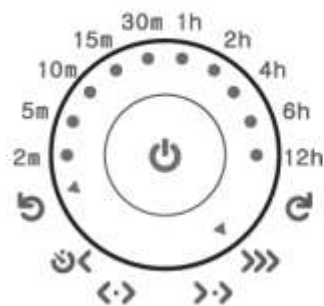

**Normal Flow 100%**

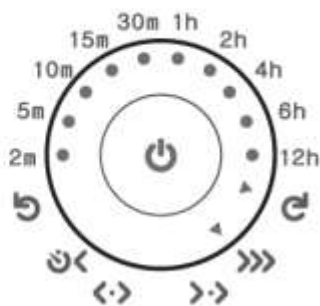

**Reverse Flow 100%**

## >> Pulsing Mode

English

1. Switch to Pulsing Mode, then enter Setup Mode.



2. First assign the water flow speed with the Control Dial using the same operation as in Constant Speed Mode.
3. For example, we will set the water flow speed at 80% as illustrated in the following diagram.

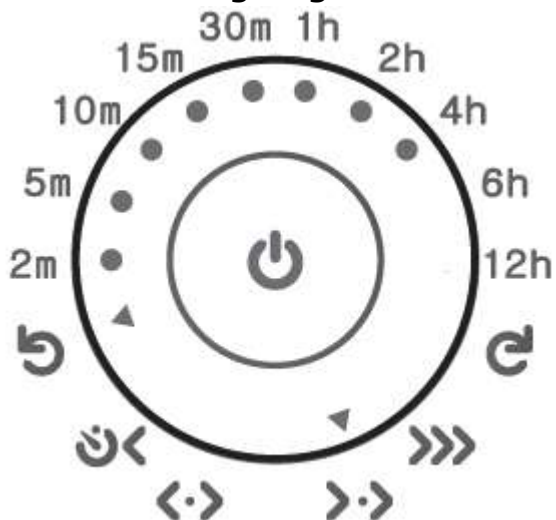

4. Once the water flow speed has been set, press the Setup Mode button again to set the pulsing speed.



## >> Pulsing Mode

5. The Indicator Lights on the Control Dial will now start to blink.

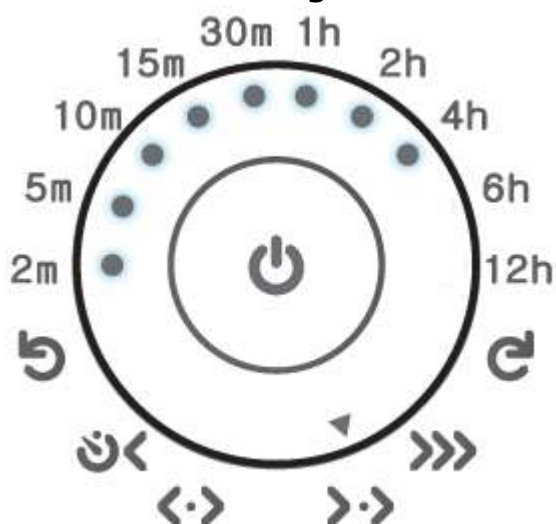

6. Rotate the Control Dial to assign the pulsing speed. The Indicator Lights will blink at the same duration as the assigned pulsing speed. There are 20 pulsing speed setting to assign, from 0.4s, 0.5s, 0.6s, 0.7s, 0.8s, 0.9s, 1s, 1.3s, 1.6s, 2s, 3s, 4s, 5s, 6s, 7s, 8s, 9s, 10s, 20s and 30s.

7. The following diagram illustrates the water flow pattern when the flow rate is 80% and pulsing at 10 seconds.

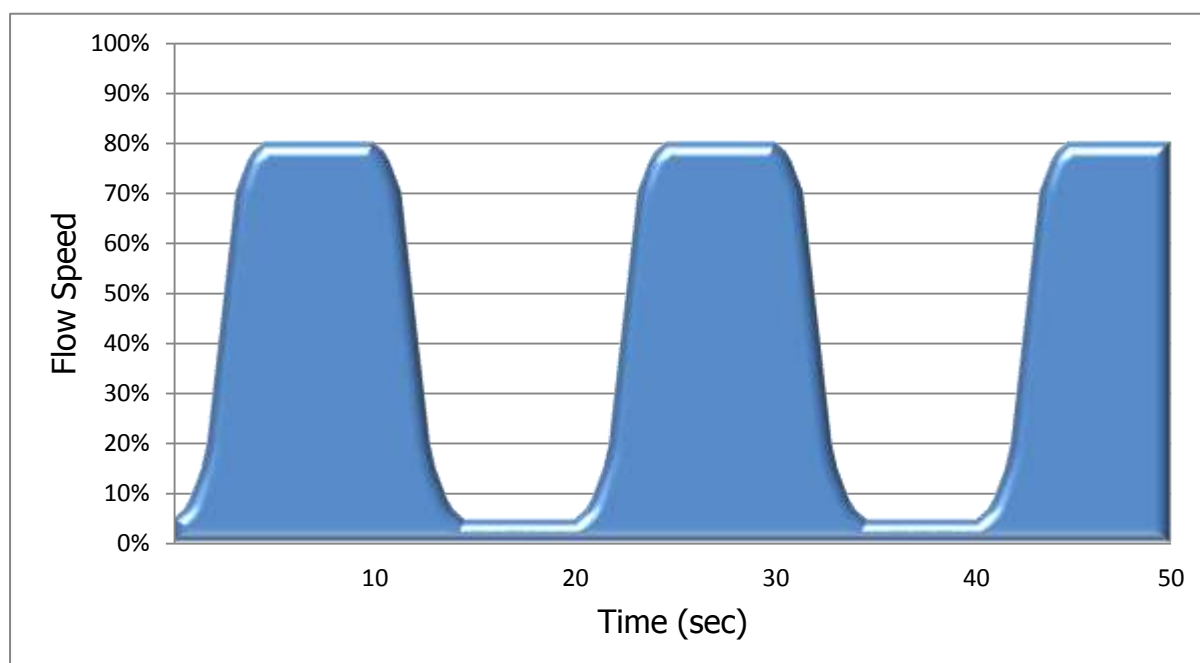

## ↔ Alternating Gyre Mode

1. Switch to Alternating Gyre Mode, then enter Setup Mode.



2. First assign the **normal water flow speed** with the Control Dial using the same operation as in Constant Speed Mode.
3. For example, we will set the **normal water flow speed** at 70% as illustrated in the following diagram.

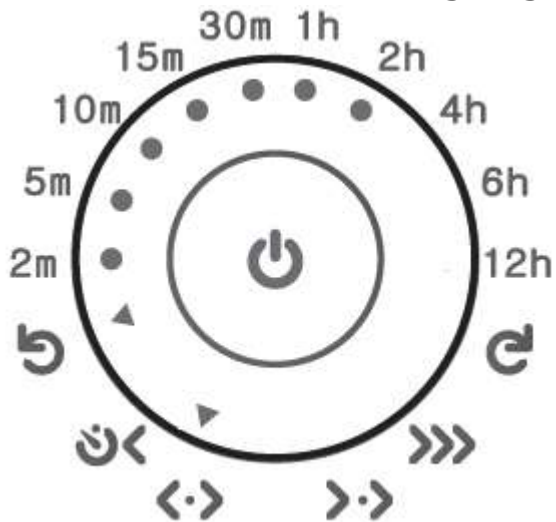

4. Once the **normal water flow speed** has been set, press the Setup Mode button again to set the **reverse water flow speed**.





## ↔ Alternating Gyre Mode

5. Next, assign the **reverse water flow speed** with the Control Dial using the same operation as in Constant Speed Mode.
6. For example, we will set the **reverse water flow speed** at 40% as illustrated in the following diagram.

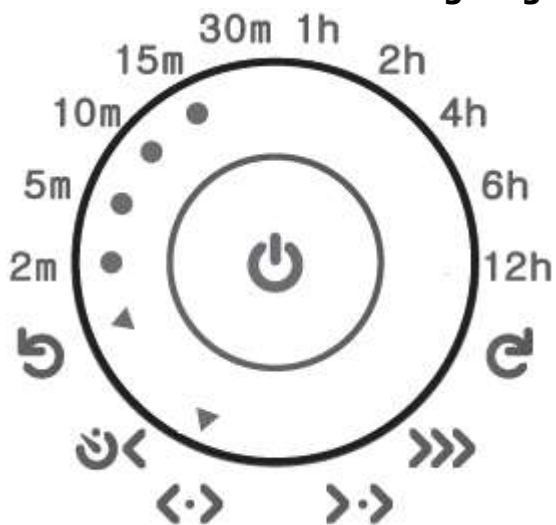

7. Once the **reverse water flow speed** has been set, press the Setup Mode button again to set the duration between each alternating flow.



8. The Indicator Lights 2-11 on the Control Dial will now start to light up according to the alternating duration. Rotate the Control Dial to assign the duration.

## Alternating Gyre Mode

English

- There are 10 settings to assign, from 2 minutes, 5 minutes, 10 minutes, 15 minutes, 30 minutes, 1 hour, 2 hours, 4 hours, 6 hours and 12 hours, as shown on the markings above the dial.
- For example, we will set the duration to 5 minutes as illustrated in the following diagram.



- The following diagram illustrates the water flow pattern when the **normal water flow speed** is 70%, **reverse water flow speed** is 40%, and alternating every 5 minutes.

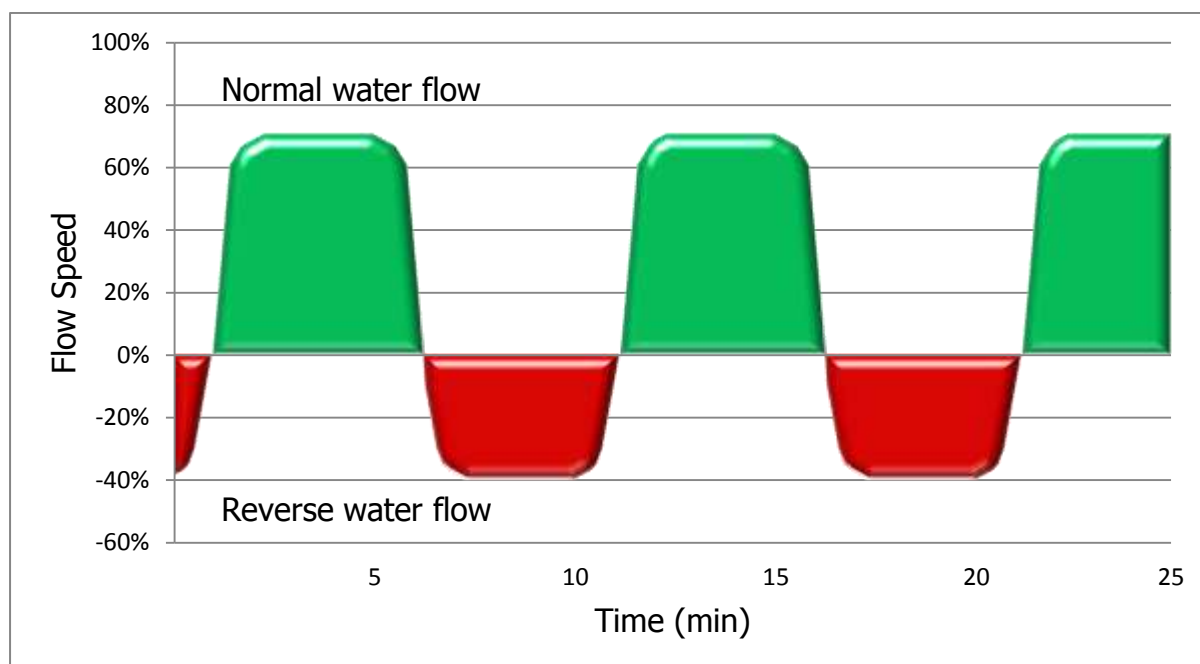

## ↔ Alternating Gyre Mode – Flow Pattern Explained

1. Depends on the way the rotors and flow cages are installed, the Gyre System could create a variety of different gyre flow patterns.
2. The following diagram illustrates the default setup of rotors and flow cages, or known as the "A-B Combination".

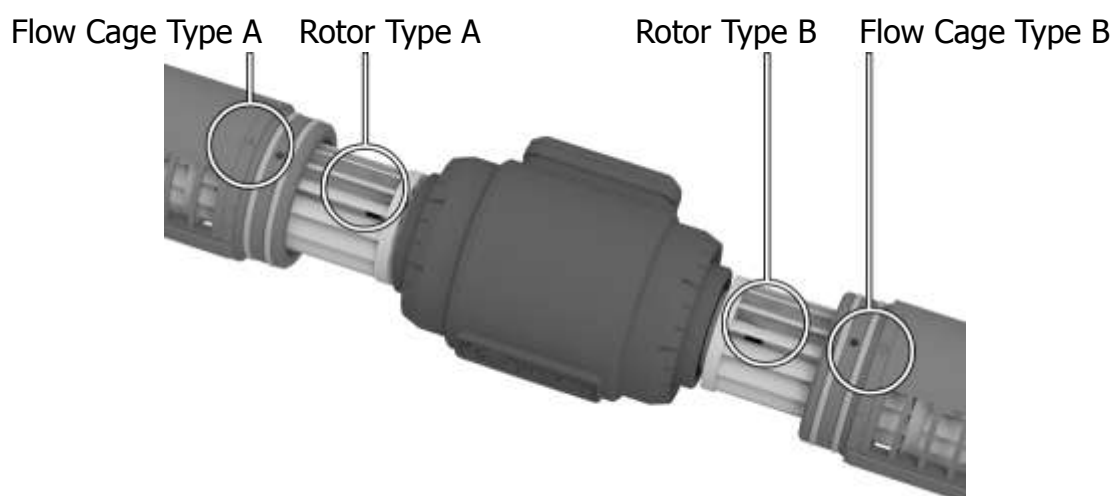

### 3. Gyre flow pattern using default "A-B Combination":

 Spinning in normal – water is drawn in from underneath and pushed out horizontally.



 Spinning in reverse – water is drawn in horizontally and disperse out downwards creating turbulence.



## ↔ Alternating Gyre Mode – Flow Pattern Explained

English

4. Each Gyre System comes packaged with an extra set of Type A and Type B rotors and flow cages. By swapping out a Type B set with the spare Type A set, you could basically be able to generate a normal and reverse gyre flow within your aquarium with just a single Gyre pump.
5. The following diagram illustrates an alternative setup of rotors and flow cages, or known as the "A-A Combination".

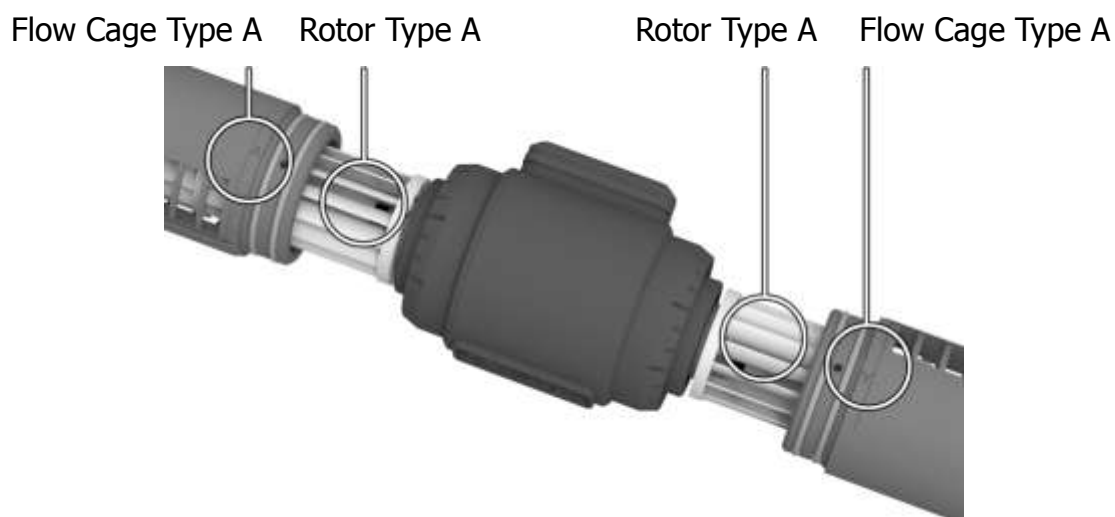

### 6. Gyre flow pattern using alternative "A-A Combination":

 Spinning in normal – one side of the Gyre pump is producing normal water flow (counter clockwise in this case), the other side of the Gyre pump is generating turbulence.

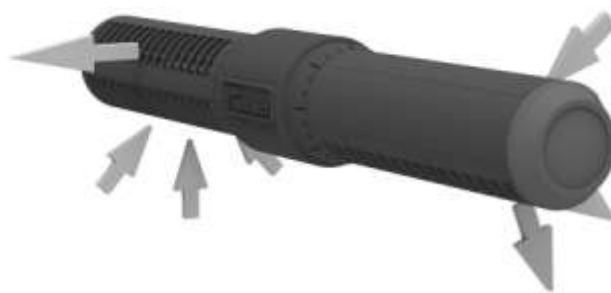

 Spinning in reverse – one side of the Gyre pump is generating turbulence, while the other side is producing normal water flow (clockwise in this case).



## ↔ Alternating Gyre Mode – Flow Pattern Explained

English

7. The following diagrams illustrate the flow pattern of "A-A Combination".

### ↻ Spinning in normal

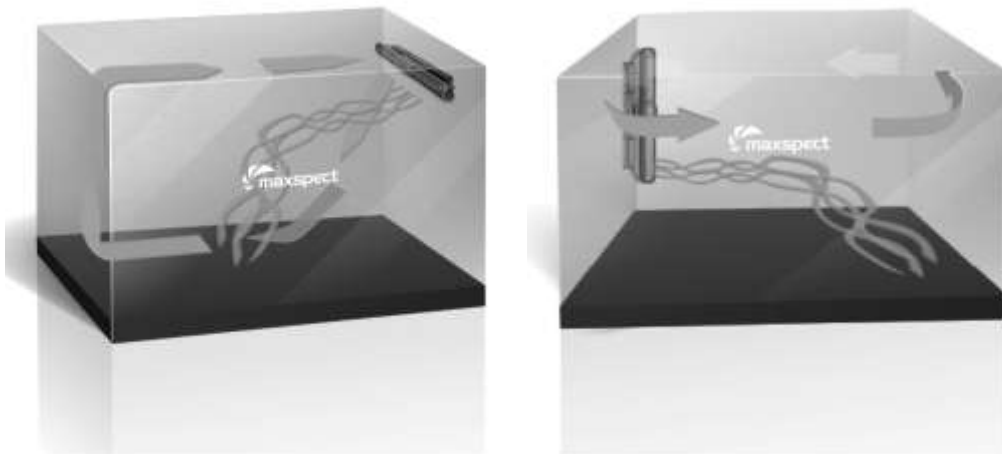

### ↻ Spinning in reverse

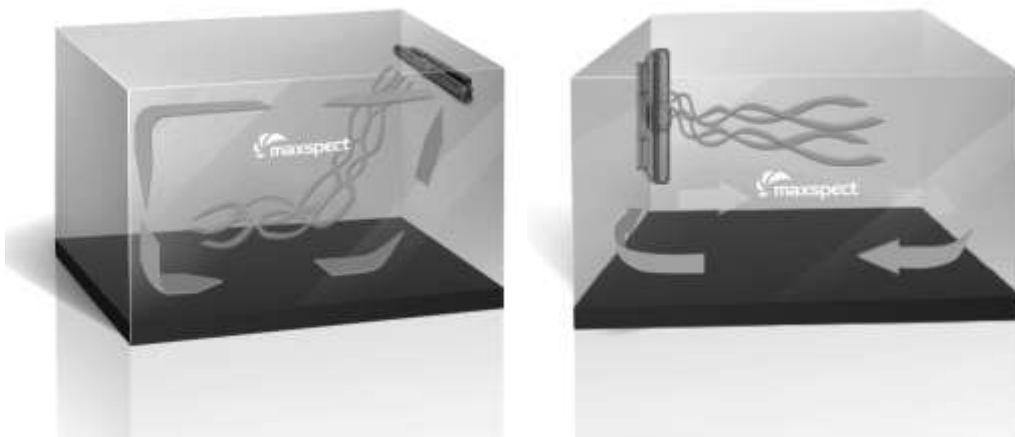

8. Similar results would happen for "B-B Combination", except the flow pattern is the exact opposite of the "A-A Combination".

9. Please also note that running either "A-A Combination" or "B-B Combination" would generate a significant amount of torque on the Gyre pump, and could slowly move the pump out of its original position in your aquarium. If this happens, either stop using this alternative setup, or purchase the optional reinforcement magnet kit.

## Feeding Mode

1. Switch to Feeding Mode.

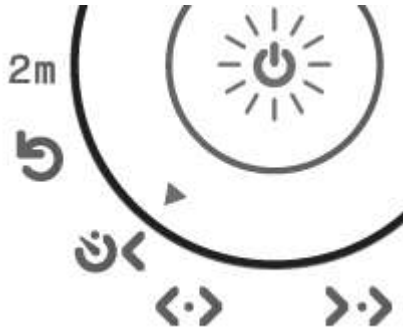

2. The Gyre pump will temporary stop for 10 minutes while you feed your inhabitants in your aquarium.
3. The Status Indicator Light will flash in blue color.



Blue Light Flashing

4. The Gyre pump will resume the previous operating mode after 10 minutes.

## Cleaning the Gyre Pump

1. It is recommended that you should clean the Gyre pump thoroughly every 3 months to ensure its optimal performance. Proper maintenance of the Gyre pump will also increase its overall lifespan and minimize the chance of mechanical failure due to debris and algae building up within the pump.
2. To clean the Gyre pump, first remove the magnet mount.



3. Next remove the bushing from the flow cages.



4. Then remove the flow cages from the motor.



## Maintenance Instructions

5. The rotors can also be removed from the motor now. Be careful not to damage the shaft while doing so.



6. The bushing, shaft holder and the shaft can now be removed from the motor. Again be careful not to damage the shaft while doing so.

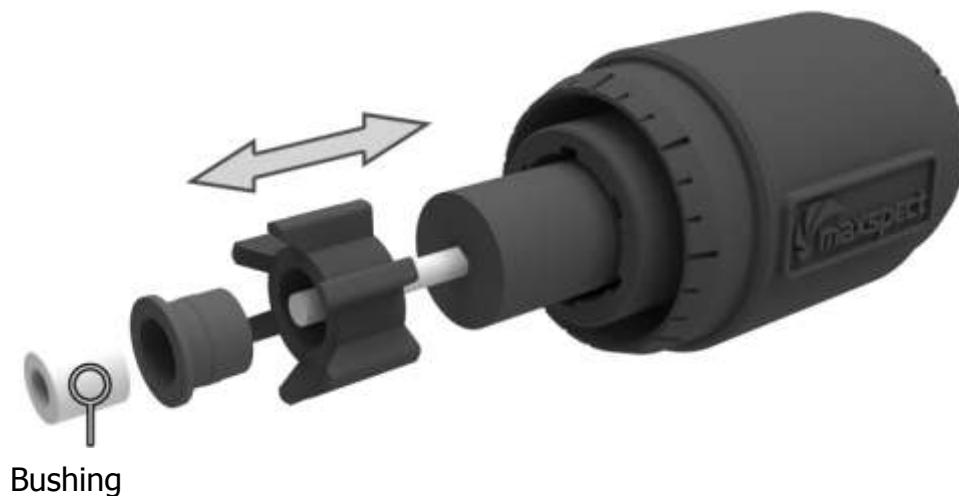

7. You can clean all the parts easily by dipping them in a mildly acidic solution, for example mixing 1 part white vinegar with 1 part water.
8. Please note that the shaft and bushings are subject to wear and tear from normal use, and will be slowly worn out after the pump has been running for a long period of time. When the Gyre pump becomes more audible and/or its vibration becomes more noticeable, then it is recommended to replace the shaft and the bushings.



## Limited Warranty

English

Maxspect Ltd. warrants all Maxspect™ Gyre products against defects in workmanship for a period of 12-months from the date of purchase. If a defect exists during the warranty period, Maxspect Ltd. at its option will either repair (using new or remanufactured parts) or replace (with a new or remanufactured unit) the product at no charge.

There is a possibility that the Gyre pump may cause damage to your aquarium. Please contact your aquarium manufacturer to determine if your aquarium is properly built and recommended for wave action. If you notice any damage to your aquarium, including but not limited to cracking, bending, scratching, etc., immediately discontinue the use of the Gyre pump. Maxspect will not be liable for any damage caused to your aquarium resulting from the use of Gyre pump.

### **DISCLAIMER OF CONSEQUENTIAL AND INCIDENTAL DAMAGES:**

THE EXPRESS WARRANTY AND REMEDIES SET FORTH ABOVE ARE EXCLUSIVE AND IN LIEU OF ALL OTHER WARRANTIES AND REMEDIES, WHETHER ORAL OR WRITTEN, EXPRESS OR IMPLIED. TO THE FULL EXTENT PERMITTED BY LAW, MAXSPECT EXPRESSLY DISCLAIMS ANY AND ALL IMPLIED WARRANTIES, INCLUDING, WITHOUT LIMITATION, THE IMPLIED WARRANTIES OF MERCHANTABILITY AND FITNESS FOR A PARTICULAR PURPOSE. IF IMPLIED WARRANTIES CANNOT BE DISCLAIMED, ALL SUCH IMPLIED WARRANTIES ARE LIMITED TO THE DURATION OF THE APPLICABLE EXPRESS WARRANTY.

MAXSPECT DOES NOT ACCEPT LIABILITY BEYOND THE REMEDIES EXPRESSLY SET FORTH IN THIS WARRANTY. IN NO EVENT SHALL MAXSPECT AND ITS DISTRIBUTORS BE LIABLE OR RESPONSIBLE FOR INCIDENTAL OR CONSEQUENTIAL DAMAGES. MAXSPECT'S AGGREGATE LIABILITY UNDER THIS WARRANTY OR WITH RESPECT TO ANY PRODUCT COVERED HEREBY, UNDER ANY LEGAL THEORY, SHALL NOT EXCEED THE PURCHASE PRICE PAID FOR THE NONCONFORMING PRODUCT.

NO ONE IS AUTHORIZED TO CHANGE THIS LIMITED WARRANTY IN ANY RESPECT OR TO CREATE ANY OTHER OBLIGATION OR LIABILITY FOR MAXSPECT IN CONNECTION WITH THE GYRE PUMP. MAXSPECT DISCLAIMS ALL LIABILITY FOR THE ACTS, OMISSIONS AND CONDUCT OF ALL THIRD PARTIES (including, without limitation, the installing contractor) IN CONNECTION WITH OR RELATED TO THE GYRE PUMP.

## Limited Warranty

UNDER NO CIRCUMSTANCES SHALL MAXSPECT AND ITS DISTRIBUTORS BE LIABLE FOR ANY INCIDENTAL, SPECIAL OR CONSEQUENTIAL DAMAGES INCLUDING, WITHOUT LIMITATION, LOST GOODWILL, LOST REVENUES OR PROFITS, WORK STOPPAGE, AQUARIUM SYSTEM FAILURE, IMPAIRMENT OF OTHER GOODS, COSTS OF REMOVAL AND REINSTALLATION OF THE GYRE PUMP, LOSS OF USE, DAMAGE TO YOUR AQUARIUM OR ANY AQUARIUM INHABITANTS, INJURY TO PERSONS OR PROPERTY ARISING OUT OR RELATED TO THE GYRE PUMP WHETHER BASED ON BREACH OF WARRANTY, BREACH OF CONTRACT, TORT OR OTHERWISE, EVEN IF MAXSPECT AND ITS DISTRIBUTORS HAVE BEEN ADVISED OF THE POSSIBILITY OF SUCH DAMAGE. IF YOU DISAGREE WITH THESE TERMS AND CONDITIONS DO NOT USE THE MAXSPECT GYRE PUMP.

English

## Specifications

English

<b>Pump Module</b>	<b>Dimensions (L x W x H)</b>	
	<b>XF150</b>	300mm × 73mm x 60mm (11.8" x 2.9" x 2.4")
	<b>Weight</b>	
	<b>XF150</b>	850g (1.9 lb)

---

<b>Power Supply Unit</b>	<b>Model</b>	GM85-360200-F
	<b>Input Voltage / Current</b>	115-230vAC 50/60Hz
	<b>Output Voltage / Current</b>	36vDC 2A
	<b>Weight</b>	300g /0.7 lb

**Note:**

For latest specifications on the Gyre pump and controller, please visit our website at [www.maxspect.com](http://www.maxspect.com)

Specifications are subject to change without notice.

Weight and dimensions are approximate.

The top corners of the page feature decorative geometric patterns. The top-left corner has a cluster of colorful triangles in shades of blue, red, green, and purple. The top-right corner has a larger, more complex cluster of similar colorful triangles, creating a starburst or crystalline effect.

## **Maxspect Company Limited**

[www.maxspect.com](http://www.maxspect.com)

NOTE: Products, packaging, features and specifications are subject to change.

All screen images are simulated.

© 2009-2014 Maxspect Limited. Reproduction in whole or in part without written permission is prohibited. All rights reserved. Maxspect and Gyre are trademarks of Maxspect Limited.

Gyre Owner's Manual Version 1.01